



Automated PFA Moulding



Paste Extrusion PTFE Facility



Van Stone Pipe Spool Manufacture



Corrosion Resistant Products Ltd.
Todmorden Road
Littleborough
Lancashire
United Kingdom
OL15 9EG

Tel. +44(0) 1706 756 400
Fax. +44(0) 1706 379 567
Email. enquiry@crp.co.uk

Contents

Page	
3.	Quality System
4.	Product Origin
5.	Product Certification
6.	General Materials of Construction
7.	Service Application Ratings
8.	Pipe Spools - Fixed / Rotating
9.	Pipe Spools - Fixed / Fixed
10.	Spacer — Type 1
11.	Spacer — Type 2
12.	Spacer — Type 3
13.	90 Degree Elbow
14.	90 Degree Long Radius (5D) Elbow
15.	45 Degree Elbow
16.	Equal Tee
17.	Reducing Tee
18.	Equal Tee with Rotating Flanges
19.	Instrument Tee
20.	Equal Cross
21.	Concentric Reducer
22.	Eccentric Reducer
23.	Reducing Flange
24.	Reducing Flange
25.	Blank Flange
26.	Blanking Spade
27.	Solid PTFE Sliding Spectacle Blind
28.	Figure 8 Spectacle Blind
29.	Toughgask Reusable Gasket
30.	CRP Flange Spray Guard Roll
31.	Flange Safety Spray Shields
32.	Static Dissipating Lined Piping
33.	Super Weight Liners For Halogen Service
34.	Continuously Lined PTFE Dip Pipe

Quality System

Corrosion Resistant Products is an ISO 9001:2015 approved company. Originally accredited to BS5750 Part 1 in 1992, CRP maintains this accreditation through a process of continuous third party surveillance with, six monthly, annual and triennial audits taking place. All of the company's manufacturing and test procedures fall within this regime.



Design and Test Standards

Products are all manufactured and tested to national and international standards where applicable, with fundamental design qualification having been undertaken via the approval process required to comply with the Pressure Equipment Directive 2014/68/EU.

Qualification Testing:	To EDSPIP 53.01C and ASTM F423/ASTM F1545.
Rating:	Full vacuum up to PN 10/16 pressure rating at 200°C for sizes up to and including 200NB.
Terminations:	Fixed flanges fitted off centres.
Dimensions:	Fitting centreline to face and face to face dimensions are in accordance with those laid down in DIN 2848 where relevant.

Product Traceability

All CRP manufactured Lined Pipe & Fittings are backwards traceable from the finished component to the manufacturing tests, processes and lining materials. Each spool has one flange stamped with the reference of the liner batch used in its construction. This provides traceability back to the liner manufacture, the tests undertaken and the materials certification of the polymer. PFA moulded items likewise are stamped with a mould reference which again provide traceability back to the manufacturing and test activities and the material certification of the polymers used.

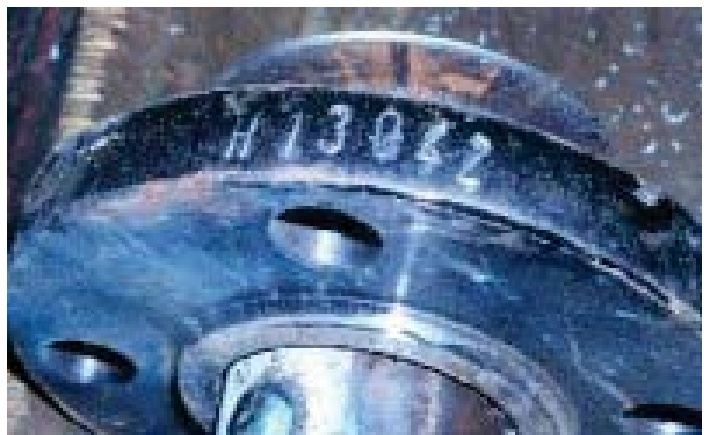

Product Origin

All Corrosion Resistant Products (CRP) manufactured products are produced in Rochdale near Manchester, England or produced locally by authorised international distributors using CRP liner in accordance with CRP manufacturing and quality assurance procedures. This both clearly establishes the origin and gives a commonality of manufacturing methods and materials – providing consistency of product standards through materials supplied.



Common Product Standards

All PTFE pipe spools are manufactured using in-house produced PTFE paste extruded liner, whilst PFA lined fittings use virgin material.

All products are painted with a corrosion resistant two component low VOC, high solids fast curing epoxy primer/finish containing zinc phosphate anti-corrosive pigmentation. Colour RAL 5015 Blue Semi-Gloss. Typical thickness 60 microns.

All products (except type 1 spacers) include suitable venting within the metal structure of the item. Typically one or more 5mm diameter holes in spools and PTFE lined fittings, and the injection boss of PFA moulded fittings.

When Vent Extensions are required, a 10mm high G 1/4 internally threaded boss is welded to pipe spools. For moulded fittings the injection boss is drilled and tapped with an appropriate female taper thread. A 65mm long vent extension is then supplied to fit to this, to provide a standard 75mm vent extension.

Special requirements

As part of the supply CRP can provide alternative special paint finishes, stainless steel spools & fittings, BS or ASME flanges, the use of static dissipating polymers, special low temperature service requirements, non-standard face to face dimensions, rotating flanges and the creation of special components for the reduction of flanges or to assist in tight access areas.

Product Identification and Packaging

All CE marked product is identified with a UV resistant, high temperature, nylon cable tie, providing manufacturers details, location and notified body CE registration number.

Additionally, product is marked in indelible marker with details of the sales order and line item for easy cross-reference to the delivery documentation and for project activity; tape colour coding is used for identifying specific isometric drawing content.



Pipe spools are finished with protective water resistant MDF end boards using BZP Roofing Bolts. PFA lined products are protected with a polyethylene end cap.

Product Certification

Standard product certification comprises a certificate of compliance and test to EN10204 type 2.2, confirming that the products supplied meet the relevant specifications, that fluoropolymers meet the requirements of the FDA regulation reference 21 CFR 177.1550 and details of the product tests undergone.

Project documentation – to customer specification. The following documentation can be supplied as evidence of quality control: Quality Plan, Product Drawings, Weld Procedures, Welder Qualifications, NDT Procedures, NDT Operator Qualification, Material Certification (2.2 or 3.1) and CRP Certificate of Conformance.

Testing

- All virgin PTFE/PFA lined products are subject to an electrostatic spark test at 25kV. All pipe spools and certain fittings are also subject to Hydrotest at 24 bar(g) for three minutes, followed by a relaxation dwell to atmospheric pressure and a repeat.
- All spools and fittings lined in static dissipating PTFE/PFA are subject to Hydrotest at 24 bar(g) for three minutes, followed by a relaxation dwell to atmospheric pressure and a repeat.
- All spools and fittings are visually examined, particularly the flare faces, to ensure that there are no defects that would prevent the item sealing against adjacent items.
- The mechanical properties and the specific gravity of representative samples of PTFE liner, selected from each sinter batch, are tested

PTFE and PFA Specifications

Liner Type

Liner Type	Specification	Properties
Virgin PTFE Paste Extruded	ASTM D4895	Minimum Tensile Strength: 26 MPa Minimum Elongation at Break: 275% Specific Gravity: 2.14 – 2.20 (when tested to ASTM D792 or D1505)
Static Dissipating PTFE Paste Extruded	ASTM D4895	Minimum Tensile Strength: 26 MPa Minimum Elongation at Break: 275% Specific Gravity: 2.14 – 2.17 (when tested to ASTM D792 or D1505) Volume Resistivity: $<10^7 \Omega \cdot \text{cm}$
Virgin PFA	ASTM D3307	Minimum Tensile Strength: 21 MPa Minimum Elongation at Break: 300% Specific Gravity: 2.12 – 2.16 (when tested to ASTM D792 or D1505) Melt Flow Rate: 1-2.5g/10mins (when tested to ASTM D3307 at 372°C)
Static Dissipating PFA	ASTM D3307	Minimum Tensile Strength: 21 MPa Minimum Elongation at Break: 300% Specific Gravity: 2.11 – 2.16 (when tested to ASTM D792 or D1505) Melt Flow Rate: 1-2.5g/10mins (when tested to ASTM D3307 at 372°C) Volume Resistivity: $<10^7 \Omega \cdot \text{cm}$

General Materials of Construction - Lined Piping

Pipe Spools	
Materials	Specification
Liner:	Virgin PTFE in accordance with ASTM D4895.
Pipe:	EN10216-2 / EN10217-2 Gr. P235GH
Stub End:	EN10222-2 Gr. P250GH / ASTM A516 GR.60
Flange:	EN10222-2 Gr. P250GH

Fabricated Fittings	
Materials	Specification
Liner:	Virgin PTFE in accordance with ASTM D4895. Virgin PTFE in accordance with ASTM D4894. Virgin PFA in accordance with ASTM D3307.
Pipe:	EN10216-2 / EN10217-2 Gr. P235GH
Wrought Fittings:	EN10253-2 Gr. P235GH
Stub Ends:	EN10222-2 Gr. P265GH / ASTM A516 GR.60
Flanges:	EN10222-2 Gr. P250GH
Carbon Steel Plate:	EN10222-2 Gr. P265GH / ASTM A516 GR.60

Spacers	
Feature	Specification
Type 1:	Virgin PTFE in accordance with ASTM D4894.
Type 2 & 3 Liner:	Virgin PTFE in accordance with ASTM D4895.
Type 2 Body:	EN10222-2 Gr. P265GH / ASTM A516 GR.60
Type 3 Pipe:	EN10216-2 / EN10217-2 Gr. P235GH
Type 3 Stub End:	EN10222-2 Gr. P265GH / ASTM A516 GR.60

Service Application Ratings

The Graph below shows the pressure / temperature performance curve for CRP's lined pipe and fittings. For products up to and including DN 200, they are rated for full vacuum up to 200 degrees C. Above DN 200 please consult CRP for vacuum performance.

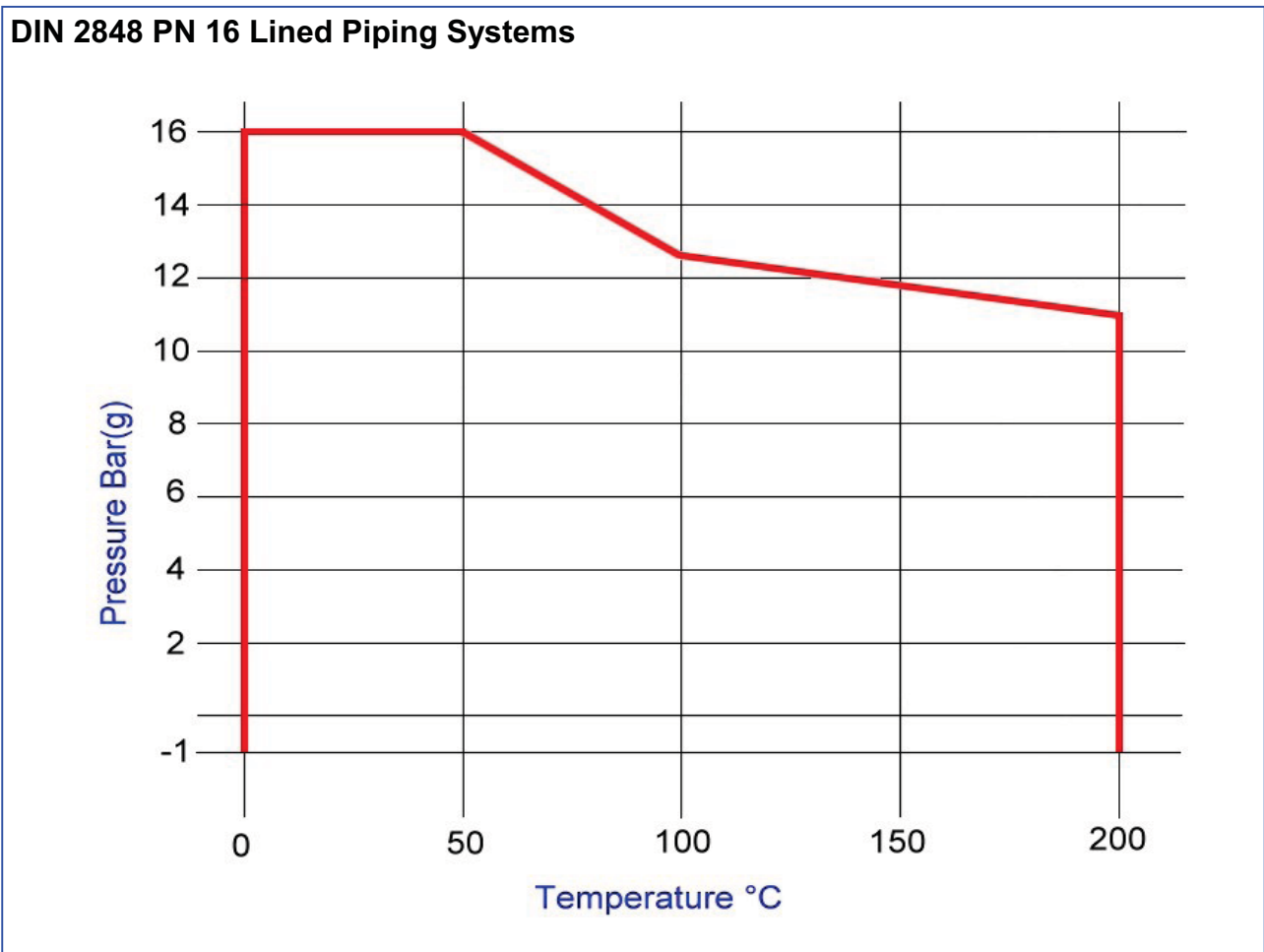
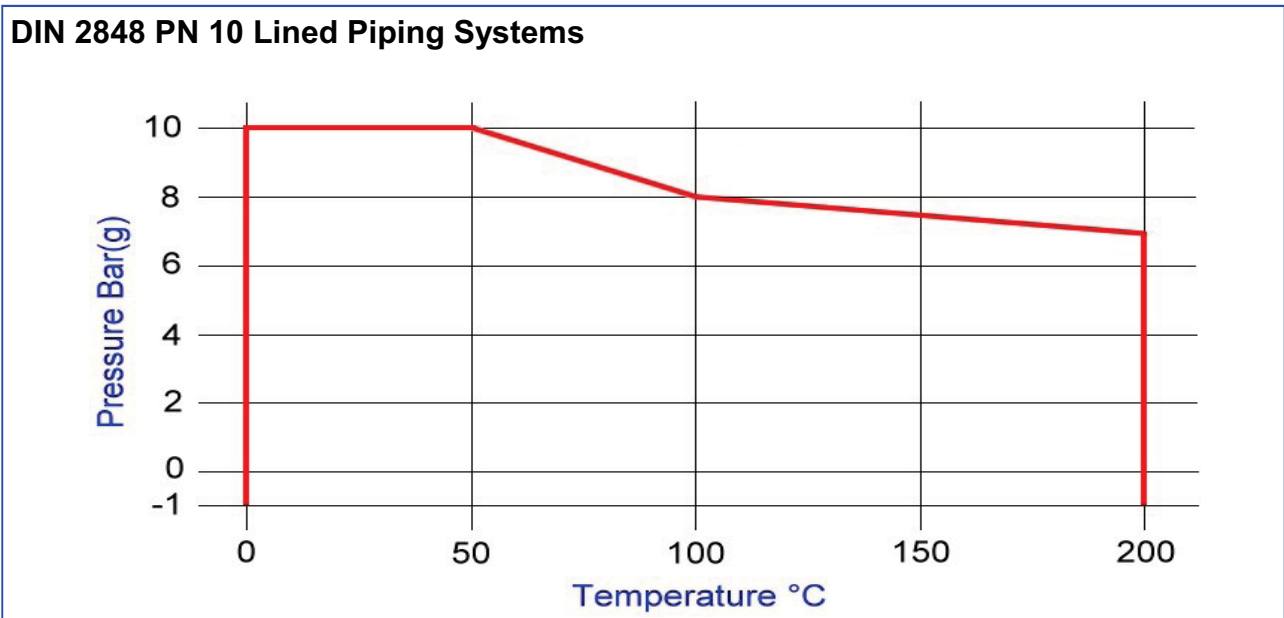

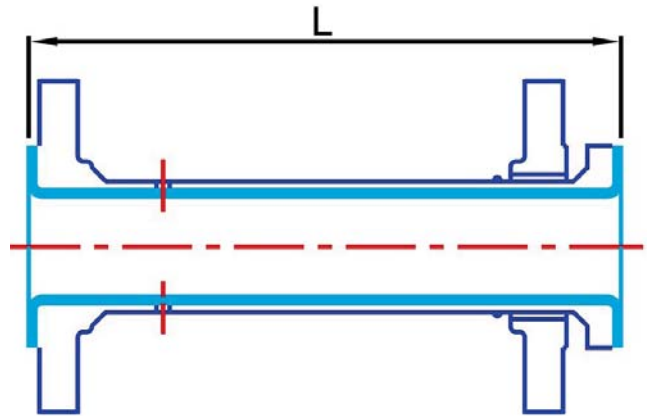

Nominal Bore	Length (L)		Flange Diameter		Raised Face	Pipe Wall	PTFE Liner Thickness
	Minimum	Maximum	PN 10	PN 16			
DN	mm	mm	mm	mm	mm	mm	mm
15	90	6000	95	95	45	2.3	2
20	90	6000	105	105	58	2.3	2
25	90	6000	115	115	68	2.6	3.3
40	95	6000	150	150	88	2.6	3.3
50	110	6000	165	165	102	2.9	3.3
80	120	6000	200	200	138	3.2	3.3
100	140	6000	220	220	158	3.6	4.5
150	150	6000	285	285	212	4.0	5.5
200	170	3000	340	340	268	4.5	4.5 or 8
250	190	3000	395	405	320	5.0	5 or 9
300	210	3000	445	460	370	5.6	5 or 9

This pipe spool has a welded slip on flange one end and rotating flange with welded stub end the other for bolt hole alignment. Each pipe spool is manufactured to the customers length requirement in 1mm increments. Spools up to and including DN 200 are full vacuum rated. For halogen services we offer spools with super weight liners, further information can be found on page 32. For shorter lengths we supply spacers.

Materials	
Pipe	EN10216-2 / EN10217-2 Gr. P235GH
Flanges	EN10222-2 Gr. P250GH
Liner	PTFE to ASTM D4895
Stub Ends	EN10222-2 Gr. P265GH / ASTM A516 GR.60

Options	
Flanges	DIN PN6, PN25, PN40
Materials	Stainless steel
Linings	Static Dissipating / Super Weight.
Extras	Spikie earthing washers, earth studs, vent extensions etc.



Vent Extensions

When the lined piping system will be lagged, please specify that the spools and fittings should be supplied with vent extensions, these 75mm long extension protrude through the lagging allowing the correct venting of the lined equipment.

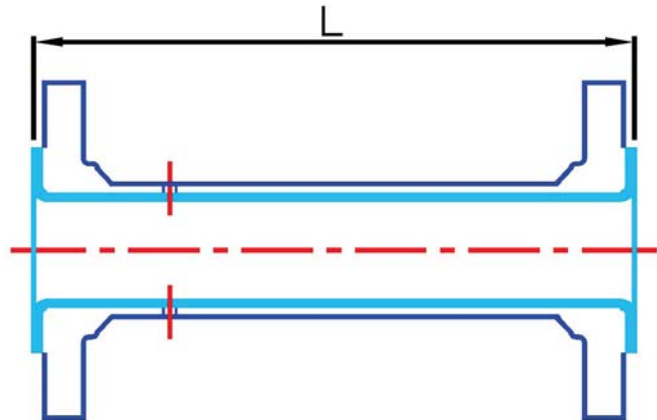
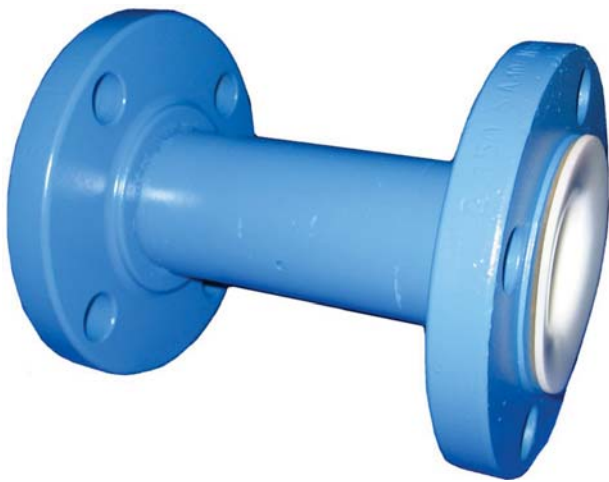

Nominal Bore	Length (L)		Flange Diameter		Raised Face	Pipe Schedule	PTFE Liner Thickness
	Minimum	Maximum	PN 10	PN 16			
DN	mm	mm	mm	mm	mm	mm	mm
15	90	6000	95	95	45	2.3	2
20	90	6000	105	105	58	2.3	2
25	90	6000	115	115	68	2.6	3.3
40	95	6000	150	150	88	2.6	3.3
50	110	6000	165	165	102	2.9	3.3
80	120	6000	200	200	138	3.2	3.3
100	140	6000	220	220	158	3.6	4.5
150	150	6000	285	285	212	4.0	5.5
200	170	6000	340	340	268	4.5	4.5 or 8
250	190	3000	395	405	320	5.0	5 or 9
300	210	3000	445	460	370	5.6	5 or 9

Each pipe spool is manufactured to the customers length requirement in 1mm increments. Spools up to and including DN 200 are full vacuum rated, with larger diameters we offer standard weight liners and heavy duty thicker wall liners suitable for vacuum duties. For halogen services we offer spools with super weight liners, further information can be found on page 32. For shorter lengths we supply spacers.

Materials	
Pipe	EN10216-2 / EN10217-2 Gr. P235GH
Flanges	EN10222-2 Gr. P250GH
Liner	PTFE to ASTM D4895

Options	
Flanges	DIN PN 6 , PN 25, DN 40
Materials	Stainless steel
Linings	Static Dissipating / Super Weight.
Extras	Spikie earthing washers, earth studs, vent extensions etc.



Venting

All lined piping systems must have vent holes drilled through the steel body. This is for 2 reasons, firstly to vent any gasses that may permeate through the liner over time to the atmosphere rather than allow them to build up behind the liner trapped within the steel pipe and secondly to act as an early warning if the liner should fail. Pipe spools less than 500mm have 2 off vent holes located centrally, longer spools have 4 vent holes 1 pair at located at each end.

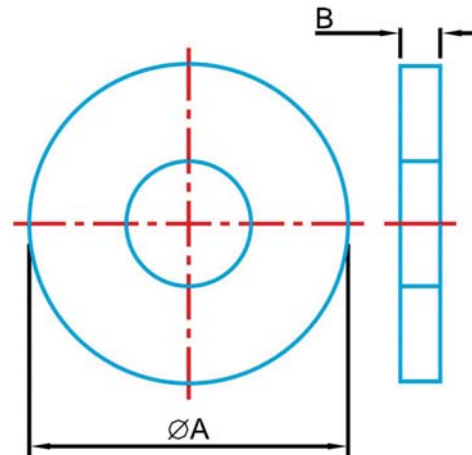

Nominal Bore	Length (B)		Diameter (A) PN 10	Diameter (A) PN 16
	Minimum	Maximum		
DN	mm	mm	mm	mm
15	1	25	50	50
20	1	25	60	60
25	1	25	70	70
40	1	25	91	91
50	1	25	106	106
80	1	25	141	141
100	1	25	161	161
150	1	25	217	217
200	1	25	272	272
250	1	25	327	327
300	1	25	377	383

Type 1 spacers are manufactured from solid PTFE and used to fill short gaps up to 25mm maximum.

Materials	
PTFE	ASTM D4894



Tapered Spacers

CRP supply tapered type 1 spacers to offer falls on pipelines to aid draining or to overcome misalignment issues with a flanged connection

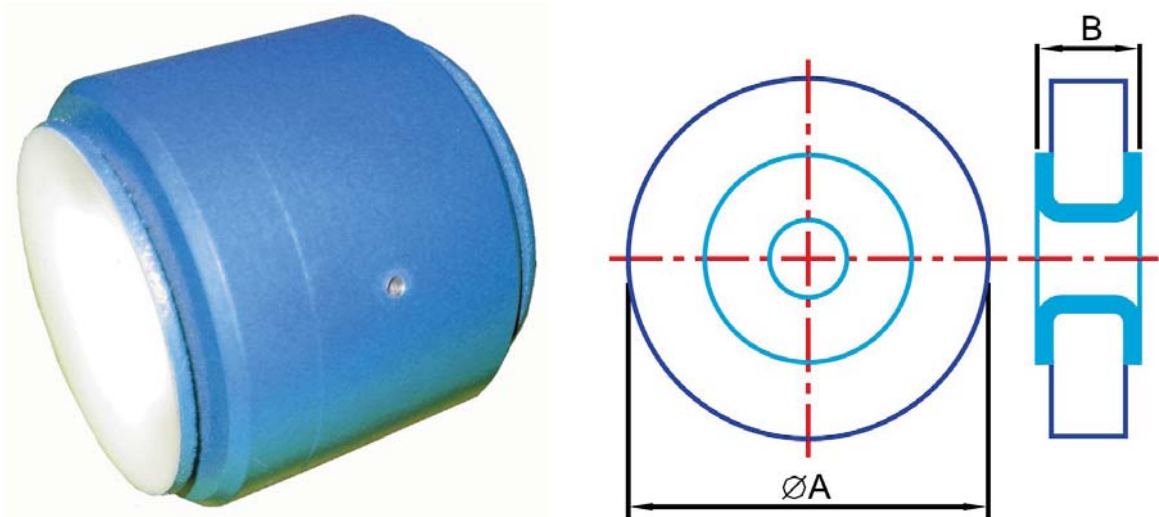

Nominal Bore	Length (B)		Diameter (A) PN 10	Diameter (A) PN 16	PTFE Liner Thickness
	Minimum	Maximum			
DN	mm	mm	mm	mm	mm
15	26	60	51	51	2
20	26	60	61	61	2
25	26	60	71	71	3.3
40	26	60	92	92	3.3
50	26	60	107	107	3.3
80	26	70	142	142	3.3
100	26	70	162	162	4.5
150	26	70	218	218	5.5
200	26	80	273	273	4.5 or 8
250	26	80	328	329	5 or 9
300	26	80	378	384	5 or 9

Type 2 spacers are manufactured from heavy wall steel tube with a PTFE lining flared each end.

Materials	
Body	EN10222-2 Gr. P265GH / ASTM A516 GR.60
Liner	PTFE to ASTM D4895

High Permeation Resistant Liners

Bromine, along with other members of the halogen family, is highly reactive. This can lead, over time, to particles permeating through fluoropolymer linings used to carry this highly corrosive chemical. Working closely with a global agricultural chemical manufacturer CRP has developed a special lined piping range utilising super-weight paste extruded PTFE liners and PFA moulded fittings. All of our piping systems can be supplied lined in these super weight liners reducing the effects of permeation. See page 34 for details.

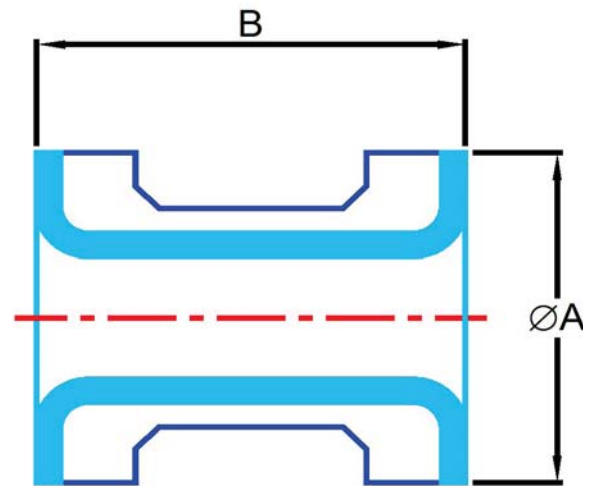

Nominal Bore	Length (B)		Diameter (A) PN 10	Diameter (A) PN 16	PTFE Liner Thickness
	Minimum	Maximum			
DN	mm	mm	mm	mm	mm
15	61	100	51	51	2
20	61	100	61	61	2
25	61	100	71	71	3.3
40	61	100	92	92	3.3
50	61	100	107	107	3.3
80	71	150	142	142	3.3
100	71	150	162	162	4.5
150	71	150	218	218	5.5
200	81	200	273	273	4.5 or 8
250	81	200	328	329	5 or 9
300	81	210	378	384	5 or 9

Type 3 spacers are manufactured from 2 stub ends and a steel pipe welded to form the housing with a PTFE liner flared each end to provide sealing faces.

Materials	
Pipe	EN10216-2 / EN10217-2 Gr. P235GH
Stub Ends	EN10222-2 Gr. P265GH / ASTM A516 GR.60
Liner	PTFE to ASTM D4895

Options	
Flanges	To suit DIN PN6 / PN25 , PN40
Materials	Stainless steel
Linings	Static Dissipating / Super Weight.
Extras	Earth studs, vent extensions etc.



Earthing Studs / Lugs

We offer all our piping with the option to have earth continuity studs or lugs welded to the pipe, flange or both depending upon site specifications.

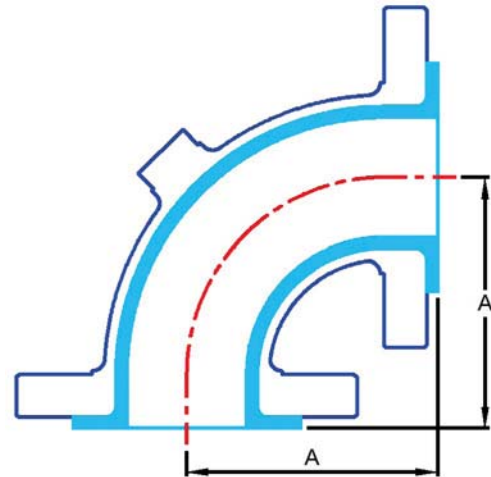

Nominal Bore	Centre Line to Face (A)	Flange Diameter		Raised Face	Steel Thickness	Liner Thickness
		PN 10	PN 16			
DN	mm	mm	mm	mm	mm	mm
15	80	45	95	45	2.3	2
20	95	105	105	58	2.3	2
25	110	115	115	68	2.6	3.3
40	150	150	150	88	2.6	3.3
50	120	165	165	102	2.9	3.3
80	165	200	200	138	3.2	3.3
100	205	220	220	158	3.6	4.5
150	285	285	285	212	4.0	5.5
200	365	340	340	268	4.5	4.5 or 8
250	450	395	405	320	5.0	5 or 9
300	525	445	460	370	5.6	5 or 9

Materials - PTFE lined Fabrications	
Pipe	EN10216-2 / EN10217-2 Gr. P235GH
Flanges	EN10222-2 Gr. P250GH
Lining	PTFE to ASTM D4895

Specials

As well as standard 45 and 90 degree elbows, CRP can supply special elbows with any angle from 1 degree up to 180 degrees which are commonly found on heat exchangers. Whilst we would encourage using standard dimensioned elbows to DIN 2848 dimensions, we can supply special elbows with swept bends for slurry duty or to overcome installation problems etc. For elbows with angles less than 45 degrees the centre-line to face dimension adopted would be the same as 45 degree elbows, For elbows with angles above 45 degrees we adopt the 90 degree centre-line to face dimensions.



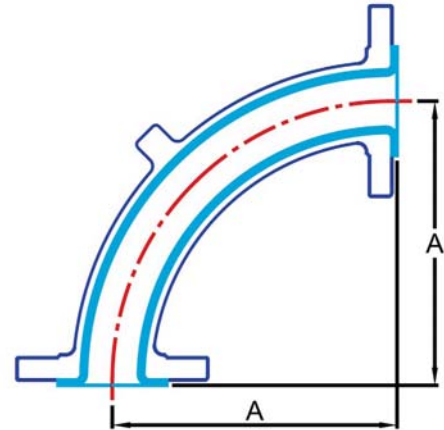

Nominal Bore	Centre Line to Face (A)	Flange Diameter		Raised Face	Steel Thickness	PTFE Liner Thickness
		PN 10	PN 16			
DN	mm	mm	mm	mm	mm	mm
25	127	115	115	68	3.4	3.3
40	191	150	150	88	3.7	3.3
50	254	165	165	102	3.9	3.3
80	381	200	200	138	5.5	3.3
100	508	220	220	158	6.0	4.5
150	762	285	285	212	7.1	5.5
200	1016	340	340	268	7.0	4.5 or 8
250	1270	395	405	320	7.8	5 or 9
300	1524	445	460	370	8.4	5 or 9

Please note DN15 and DN20 5D long radius bends are not available

These swept bends are ideal for use with slurries. The centreline to faces are based on 5 times the nominal bore.

Materials - PTFE lined Fabrications	
Pipe	EN10216-2 / EN10217-2 Gr. P235GH
Flanges	EN10222-2 Gr. P250GH
Lining	PTFE to ASTM D4895

Specials

As well as standard 45 and 90 degree elbows, we can supply special elbows with any angle from 1 degree up to 180 degree which are commonly found on heat exchangers. Whilst we would encourage using standard dimensioned elbows to DIN 2848 dimensions, we can supply special elbows with swept bends for slurry duty or to overcome installation problems etc. For elbows with angles less than 45 degrees the centre-line to face dimension adopted would be the same as 45 degree elbows, For elbows with angles above 45 degrees we adopt the 90 degree centre-line to face dimensions.



Hose Adaptors

CRP manufacture PFA lined camlock, triclamp and threaded flanged hose adaptors.



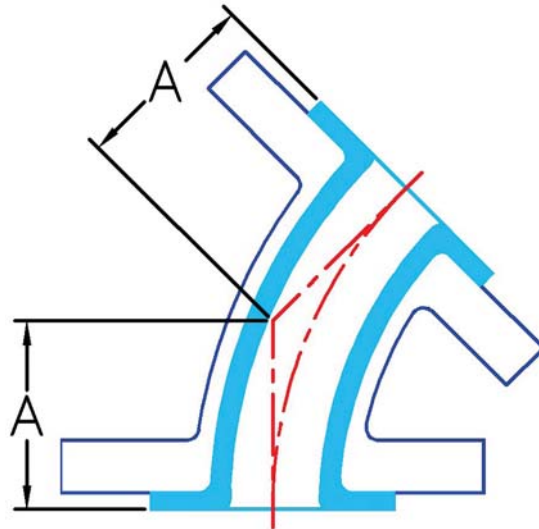

Nominal Bore	Centre Line to Face (A)	Flange Diameter PN 10	Flange Diameter PN 16	Raised Face	Steel Thickness	PTFE Liner Thickness
DN	mm	mm	mm	mm	mm	mm
15	60	95	95	45	2.3	2
20	65	105	105	58	2.3	2
25	70	115	115	68	2.6	3.3
40	90	150	150	88	2.6	3.3
50	80	165	165	102	2.9	3.3
80	100	200	200	138	3.2	3.3
100	115	220	220	158	3.6	4.5
150	150	285	285	212	4.0	5.5
200	190	340	340	268	4.5	4.5 or 8
250	225	395	405	320	5.0	5 or 9
300	260	445	460	370	5.6	5 or 9

Materials - PTFE lined Fabrications	
Pipe	EN10216-2 / EN10217-2 Gr. P235GH
Flanges	EN10222-2 Gr. P250GH
Lining	PTFE to ASTM D4895

Specials

As well as standard 45 and 90 degree elbows, we can supply special elbows with any angle from 1 degree up to 180 degree which are commonly found on heat exchangers. Whilst we would encourage using standard dimensioned elbows to DIN 2848 dimensions, we can supply special elbows with swept bends for slurry duty or to overcome installation problems etc. For elbows with angles less than 45 degrees the centre-line to face dimension adopted would be the same as 45 degree elbows, For elbows with angles above 45 degrees we adopt the 90 degree centre-line to face dimensions.



Blanking Spades

CRP supply a full range of PTFE lined blanking spades for positive line shutoff in shutdown and maintenance instructions.

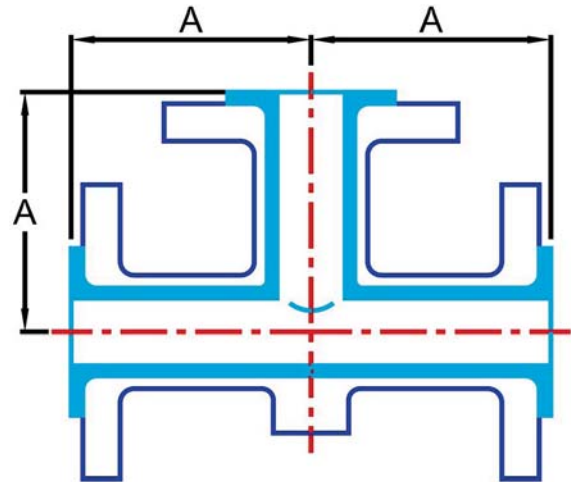

Nominal Bore	Centre Line to Face (A)	Flange Diameter		Raised Face	Steel Thickness	Liner Thickness
		PN 10	PN 16			
DN	mm	mm	mm	mm	mm	mm
15	85	95	95	45	2.3	3.5
20	95	105	105	58	2.3	3.5
25	110	115	115	68	2.6	4.6
40	150	150	150	88	2.6	4.6
50	120	165	165	102	2.9	4.7
80	165	200	200	138	3.2	5.0
100	205	220	220	158	3.6	6.0
150	285	285	285	212	4.0	8.6
200	365	340	340	268	4.5	9.5
250	450	395	405	320	5.0	11.0
300	525	445	460	370	5.6	11.0

Materials - PFA lined Fabrications	
Pipe	EN10216-2 / EN10217-2 Gr. P235GH
Flanges	EN10222-2 Gr. P250GH
Lining	PFA to ASTM D3307

Tee Range

CRP offer the widest range of PFA lined tees:

- Equal Tees
- Reducing Tees
- Short Branch Tees
- Lateral Tees
- Instrument Tees

Any of these can be supplied with fixed or rotating flanges to aid installation.

The PFA linings offer the best permeation resistance and smoothest bores, it's non-wettable properties are excellent and allow easy cleaning.



Stainless Steel Lined Pipe and Fittings

CRP can supply our complete range in stainless steel. We have developed the range to provide a very cost effective alternative to lined carbon steel.



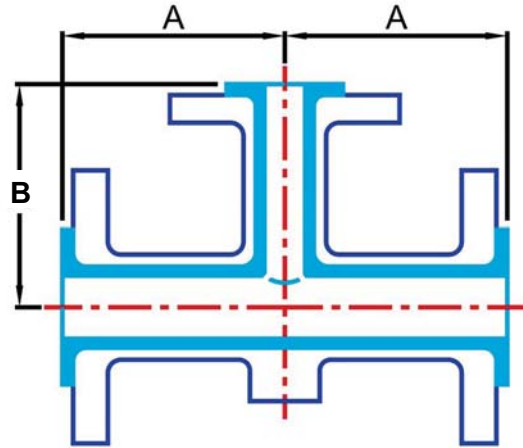

Nominal Bore	Centre Line to Face		Large NB Flange Ø		Large NB Raised Face	Small NB Flange Ø		Small NB Raised Face
	(A)	(B)	PN 10	PN 16		PN 10	PN 16	
DN	mm	mm	mm	mm	mm	mm	mm	mm
20 x 15	95	80	105	105	58	95	95	45
25 x 20	110	95	115	115	68	105	105	58
40 x 25	150	110	115	150	88	115	115	68
50 x 25	120	110	165	165	102	115	115	68
50 x 40	120	150	165	165	102	150	150	88
80 x 25	165	110	200	200	138	115	115	68
80 x 40	165	150	200	200	138	150	150	88
80 x 50	165	120	200	200	138	165	165	102
100 x 25	205	110	220	220	158	115	115	68
100 x 40	205	150	220	220	158	150	150	88
100 x 50	205	120	220	220	158	165	165	102
100 x 80	205	165	220	220	158	200	200	138
150 x 80	285	165	285	285	212	200	200	138
150 x 100	285	205	285	285	212	220	220	158
200 x 100	365	205	340	340	268	220	220	158
200 x 150	365	285	340	340	268	285	285	212
250 x 150	450	285	395	405	320	285	285	212
250 x 200	450	365	395	405	320	340	340	268
300 x 150	525	285	445	460	370	285	285	212
300 x 200	525	365	445	460	370	340	340	268
300 x 250	525	450	445	460	370	395	405	320

Materials - PFA lined Fabrications	
Pipe	EN10216-2 / EN10217-2 Gr. P235GH
Flanges	EN10222-2 Gr. P250GH
Lining	PFA to ASTM D3307

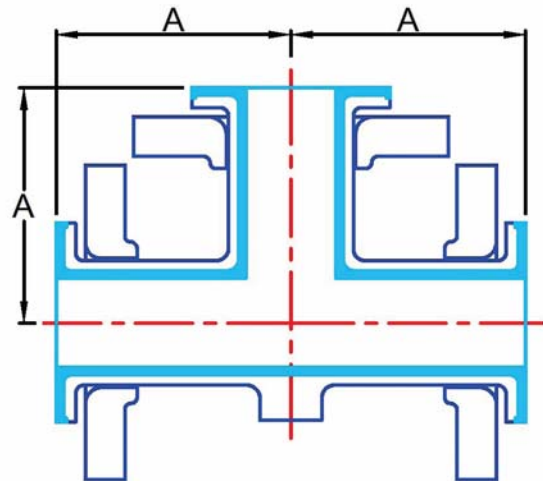

Nominal Bore	Centre Line to Face (A)	Flange Diameter		Raised Face	Steel Thickness	Liner Thickness
		PN 10	PN 16			
DN	mm	mm	mm	mm	mm	mm
15	85	95	95	45	2.3	3.5
20	95	105	105	58	2.3	3.5
25	110	115	115	68	2.6	4.6
40	150	150	150	88	2.6	4.6
50	120	165	165	102	2.9	4.7
80	165	200	200	138	3.2	5.0
100	205	220	220	158	3.6	6.0
150	285	285	285	212	4.0	8.6
200	365	340	340	268	4.5	9.5
250	450	395	405	320	5.0	11.0
300	525	445	460	370	5.6	11.0

Materials - PFA / PTFE lined Fabrications	
Pipe	EN10216-2 / EN10217-2 Gr. P235GH
Flanges	EN10222-2 Gr. P250GH
Lining	PTFE to ASTM D4894 / PFA to ASTM D3307.

Reducing Tees with Rotating Flanges
 CRP can supply reducing tees with rotating flanges too.

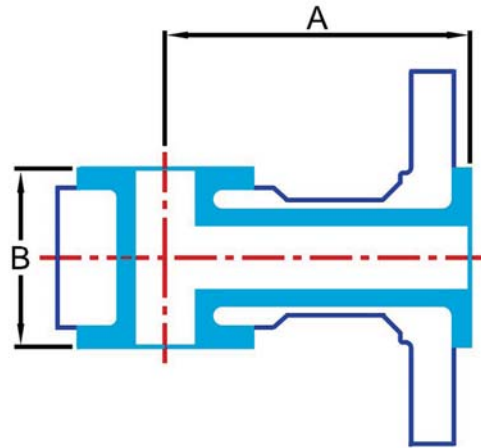

Nominal Bore	Centre Line to Face (A)	Face to Face (B)
DN	mm	mm
15 x 15	90	50
20 x 15	90	50
20 x 20	90	50
25 x 15	90	50
25 x 20	90	50
25 x 25	90	50
40 x 25	110	50
40 x 40	110	75
50 x 25	115	50
50 x 40	115	75
50 x 50	115	90
80 x 25	135	50
100 x 25	150	50

Nominal Bore	Centre Line to Face (A)	Face to Face (B)
DN	mm	mm
100 x 40	150	75
150 x 25	180	50
150 x 40	180	75
150 x 50	180	90
200 x 25	210	50
200 x 40	210	75
200 x 50	210	90
250 x 25	240	50
250 x 50	240	90
300 x 25	340	50
300 x 40	340	75
300 x 50	340	90

Materials - PFA lined Fabrications	
Pipe	EN10216-2 / EN10217-2 Gr. P235GH
Flanges	EN10222-2 Gr. P250GH
Body	EN10222-2 Gr. P265GH / ASTM A516 GR.60
Lining	PFA to ASTM D3307

Tee Range
CRP offer the widest range of PFA lined tees: Equal Tees Reducing Tees Short Branch Tees Lateral Tees Instrument Tees Some of these can be supplied with rotating flanges to aid installation. The PFA linings offer the best permeation resistance and smoothest bores, it's nonwetable properties are excellent and allow easy cleaning.

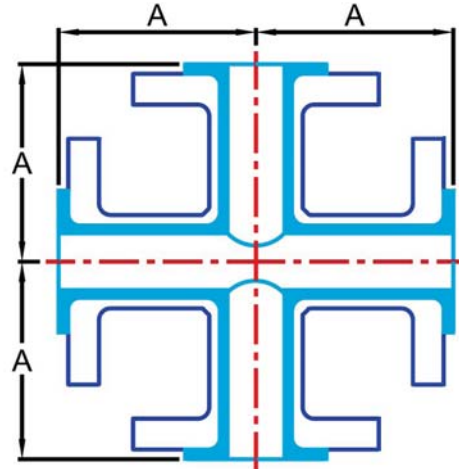

Nominal Bore	Centre Line to Face (A)	Flange Diameter		Raised Face	Steel Thickness	Liner Thickness
		PN 10	PN 16			
DN	mm	mm	mm	mm	mm	mm
15	85	95	95	45	2.3	3.5
20	95	105	105	58	2.3	3.5
25	110	115	115	68	2.6	4.6
40	150	150	150	88	2.6	4.6
50	120	165	165	102	2.9	4.7
80	165	200	200	138	3.2	5.0
100	205	220	220	158	3.6	6.0
150	285	285	285	212	4.0	8.6
200	365	340	340	268	4.5	9.5
250	450	395	405	320	5.0	11.0
300	525	445	460	370	5.6	11.0

Materials - PFA lined Fabrications	
Pipe	EN10216-2 / EN10217-2 Gr. P235GH
Flanges	EN10222-2 Gr. P250GH
Lining	PFA to ASTM D3307

Reducing Crosses

CRP can also supply reducing crosses upon request, body and branch centre line to face dimensions are the same as a reducing tee.

Stainless Steel Lined Pipe and Fittings

CRP can supply our complete range in stainless steel, we have developed the range to provide a very cost effective alternative to lined carbon steel.

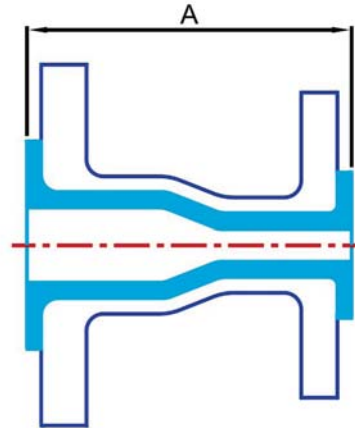

Nominal Bore	Face to Face (A)	Large NB Flange Ø		Large NB Raised Face	Small NB Flange Ø		Small NB Raised Face
		PN 10	PN 16		PN10	PN 16	
DN	mm	mm	mm	mm	mm	mm	mm
20 x 15	125	105	105	58	95	95	45
25 x 20	125	115	115	68	105	105	58
40 x 25	145	150	150	88	115	115	68
50 x 25	160	165	165	102	115	115	68
50 x 40	165	165	165	102	150	150	88
80 x 25	185	200	200	138	115	115	68
80 x 40	185	200	200	138	150	150	88
80 x 50	190	200	200	138	165	165	102
100 x 50	200	220	220	158	165	165	102
100 x 80	205	220	220	158	200	200	138
150 x 80	250	285	285	212	200	200	138
150 x 100	250	285	285	212	220	220	158
200 x 100	270	340	340	268	220	220	158
200 x 150	270	340	340	268	285	285	212
250 x 150	305	395	405	320	285	285	212
250 x 200	310	395	405	320	340	340	268
300 x 200	335	445	460	370	340	340	268
300 x 250	340	445	460	370	395	405	320

Materials - PFA / PTFE lined Fabrications	
Pipe	EN10216-2 / EN10217-2 Gr. P235GH
Reducer	EN10253-2 Gr. P235GH
Flanges	EN10222-2 Gr. P250GH
Lining	PTFE to ASTM D4895 / PFA to ASTM D3307

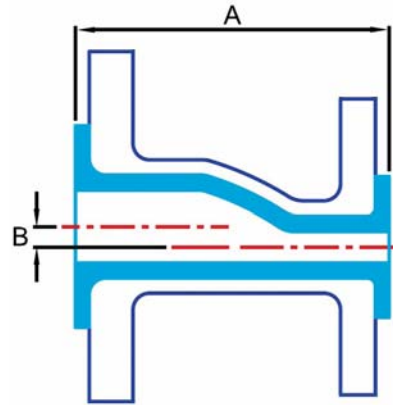

Nominal Bore	Face to Face (A)	Offset (B)	Large NB Flange Ø		Large NB Raised Face	Small NB Flange Ø		Small NB Raised Face
			PN 10	PN 16		PN 10	PN 16	
DN	mm	mm	mm	mm	mm	mm	mm	mm
20 x 15	125	2.8	105	105	58	95	95	45
25 x 20	125	3.4	115	115	68	105	105	58
40 x 25	145	7.3	150	150	88	115	115	68
50 x 25	160	13.3	165	165	102	115	115	68
50 x 40	165	6	165	165	102	150	150	88
80 x 25	185	27.6	200	200	138	115	115	68
80 x 40	185	20.3	200	200	138	150	150	88
80 x 50	190	14.3	200	200	138	165	165	102
100 x 50	200	27	220	220	158	165	165	102
100 x 80	205	12.7	220	220	158	200	200	138
150 x 80	250	39.7	285	285	212	200	200	138
150 x 100	250	27	285	285	212	220	220	158
200 x 100	270	52.4	340	340	268	220	220	158
200 x 150	270	25.4	340	340	268	285	285	212
250 x 150	305	52.4	395	405	320	285	285	212
250 x 200	310	27	395	405	320	340	340	268
300 x 200	335	52.4	445	460	370	340	340	268
300 x 250	340	25.5	445	460	370	395	405	320

Materials—PFA / PTFE lined Fabrications	
Pipe	EN10216-2 / EN10217-2 Gr. P235GH
Reducer	EN10253-2 Gr. P235GH
Flanges	EN10222-2 Gr. P250GH
Liner	PTFE to ASTM D4895 / PFA to ASTM D3307

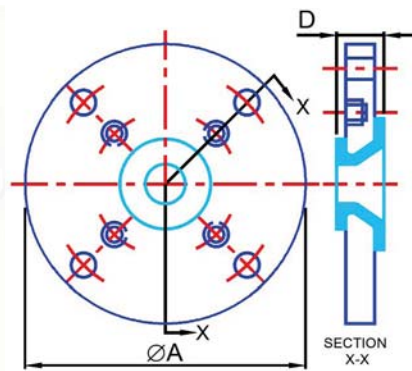

Type 3

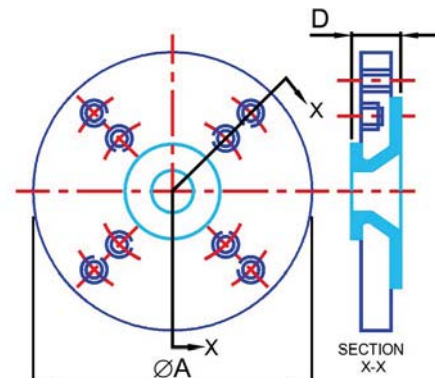

Type 2

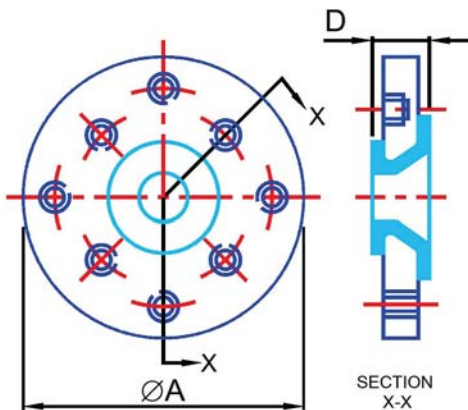

Type 1

Bolt hole configuration

Reducing flanges are supplied in 3 configurations – Type 1, 2 & 3, The configuration is dictated by the proximity of the small bore bolt holes to the large bore bolt holes. Each type is designed so that they do not clash and that the nuts can be fitted successfully. Type 3 flanges have through holes for the large bore bolts and are used where there is a significant reduction in bores. Where the reduction is not so great and the periphery of the smaller bore mating flange would impinge on the nuts then a type 2 flange is employed with threaded bolt holes negating the use of nuts. Finally where the reduction in bores is quite small the bolt holes have to be staggered on / off centres so that they don't clash – a type 1 reducing flange.

Nominal Bore	Flange Type	Face to Face (D)	Diameter		Liner Thickness
			PN 10	PN 16	
DN		mm	mm	mm	mm
20 x 15	1	30	105	105	5
25 x 15	1	30	115	115	5
25 x 20	1	30	115	115	5
40 x 15	2	30	150	150	5
40 x 20	2	30	150	150	5
40 x 25	1	30	150	150	5
50 x 15	3	30	165	165	5
50 x 20	2	30	165	165	5
50 x 25	2	30	165	165	5
50 x 40	1	35	165	165	5
80 x 20	3	35	200	200	5
80 x 25	3	35	200	200	5
80 x 40	2	35	200	200	5

Nominal Bore	Flange Type	Face to Face (D)	Diameter		Liner Thickness
			PN 10	PN 16	
DN		mm	mm	mm	mm
80 x 50	1	35	200	200	5
100 x 20	3	35	220	220	5
100 x 25	3	35	220	220	5
100 x 40	3	35	220	220	5
100 x 50	2	35	220	220	5
100 x 80	1	35	220	220	5
150 x 25	3	40	285	285	5
150 x 40	3	40	285	285	5
150 x 50	3	40	285	285	5
150 x 80	3	40	285	285	5
150 x 100	2	40	285	285	5
200 x 25	3	35	340	340	5
200 x 40	3	35	340	340	5
200 x 50	3	40	340	340	5
200 x 80	3	40	340	340	5
200 x 100	3	40	340	340	5
200 x 150	2	40	340	340	5
250 x 50	3	35	395	405	4
250 x 80	3	35	395	405	4
250 x 100	3	35	395	405	4
250 x 150	3	35	395	405	4
250 x 200	2	35	395	405	4
300 x 50	3	35	445	460	4
300 x 80	3	35	445	460	4
300 x 100	3	35	445	460	4
300 x 150	3	35	445	460	4
300 x 200	3	35	445	460	4
300 x 250	2	35	445	460	4

Materials	
Steelwork	EN10222-2 Gr. P265GH / ASTM A516 GR.60
Lining	PFA to ASTM D3307 or PTFE to ASTM D4895

Special Reducing Flanges

CRP can manufacture much larger flanges than listed. We can manufacture special adaptor flanges eg DIN to ASME or BS10 to ASME and can also supply other sizes not listed such as DN 300 x DN 20, DN 65 x DN 25 etc.

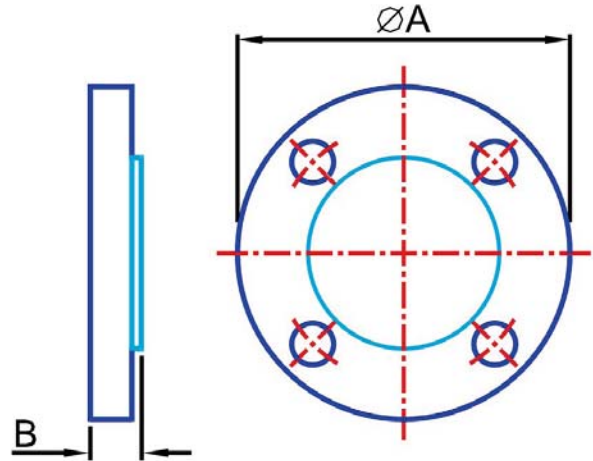

Nominal Bore	Flange Diameter (A)		Raised Face	Flange Thickness (B) PN10	PTFE Liner Thickness
	PN 10	PN 16			
DN	mm	mm	mm	mm	mm
15	95	95	45	19	3
20	105	105	58	21	3
25	115	115	68	21	3
40	150	150	88	21	3
50	165	165	102	21	3
80	200	200	138	23	3
100	220	220	158	23	3
150	285	285	212	25	3
200	340	340	268	27	3
250	395	405	320	29	3
300	445	460	370	29	3

Materials	
Flange	EN10222-2 Gr. P250GH
PTFE	ASTM D4894



Traceability and Testing

All lined equipment is traceable back through hard stamped references on the flanges to the original PFA or PTFE batch numbers. Liners are subjected to tensile testing and finished components subjected to electrostatic and hydrostatic testing.



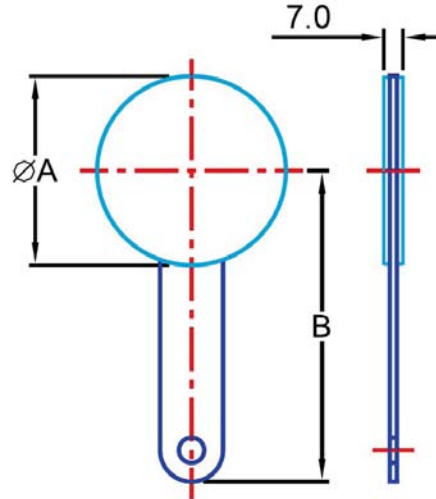

Nominal Bore	Spade Diameter (A) PN10	Handle Length (B)	PTFE Liner Thickness
DN	mm	mm	mm
15	51	102	2
20	61	110	2
25	71	148	2
40	92	156	2
50	107	162	2
80	142	178	2
100	162	194	2
150	218	220	2
200	273	250	2
250	328	300	2
300	378	340	2

Materials	
Flange	1.4301 (304 St. Steel)
PTFE	ASTM D4894



Orifice Plates

CRP can supply solid PTFE orifice plates with holes drilled to suit your application. Orifice plates can be used to control flow or help in flow measurement. We can supply them to suit a wide range of pipe nominal bores, they are generally supplied in virgin PTFE but other materials can be provided.

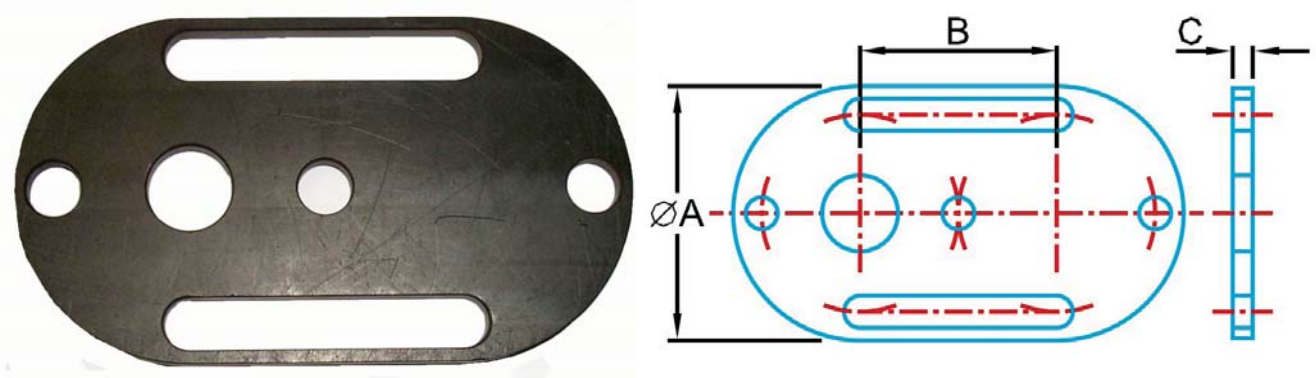

Nominal Bore	Flange Diameter (A)		Dimension (B)		Face to Face (C)
	PN 10	PN 16	PN 10	PN 16	
DN	mm	mm	mm	mm	mm
15	95	95	65	65	10
20	105	105	75	75	10
25	115	115	85	85	10
40	150	150	110	110	10
50	165	165	125	125	16
80	200	200	160	160	16
100	220	220	180	180	27
150	285	285	240	240	27
200	340	340	295	295	27
250	395	405	350	355	27
300	445	460	400	410	27

Materials	
PTFE	ASTM D4894

User Manual

Installation and Operating Guidance

Detailed storage, installation and operation guidance can be found for all CRP products in our handy "User Manual" This is supplied with all deliveries and can also be downloaded from our website from the Technical Info section.

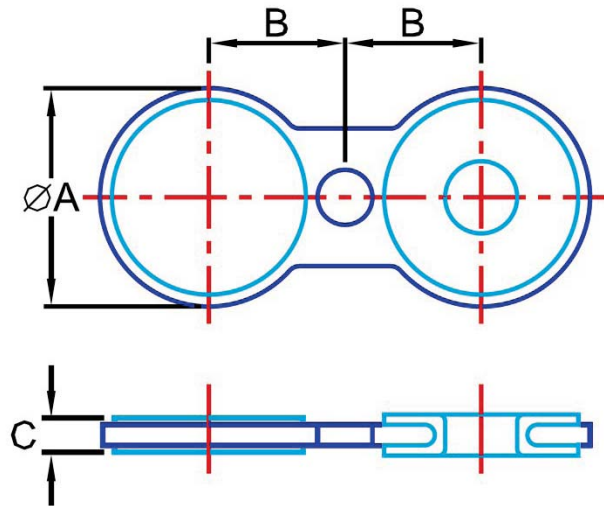

Nominal Bore	Diameter (A)		Dimension (B)		Face to Face (C)
	PN 10	PN 16	PN 10	PN 16	
DN	mm	mm	mm	mm	mm
15	51	51	32.5	32.5	11
20	61	61	37.5	37.5	11
25	71	71	42.5	42.5	11
40	92	92	55.0	55.0	11
50	107	107	62.5	62.5	11
80	142	142	80.0	80.0	11
100	162	162	90.0	90.0	11
150	218	218	120.0	120.0	19
200	273	273	147.5	147.5	19
250	328	329	175.0	177.5	28
300	378	384	200.0	205.0	28

Materials	
Steelwork	ASTM A516 GR.60
PTFE	ASTM D4894 / 4895



ISO 9001:2015 Accreditation

CRP is an ISO 9001:2015 approved company. Originally accredited to BS5750 Part 1 in 1992, CRP maintains this accreditation through a process of continuous third party surveillance with, six monthly, annual and triennial audits taking place. The company was one of the first in the UK to obtain approval to the upgraded version ISO 9001:2015. All of the company's manufacture and test procedures fall within this regime.

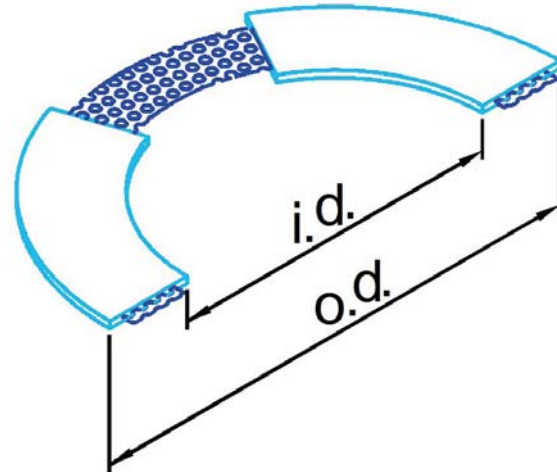

Nominal Bore	Gasket o.d. PN 10	Gasket o.d. PN 16	Gasket i/d PN 10	Gasket i/d PN 16	Thickness
DN	mm	mm	mm	mm	mm
15	50	50	22	22	3.0
20	60	60	28	28	3.0
25	70	70	35	35	3.0
40	92	92	49	49	3.0
50	107	107	61	61	3.0
80	142	142	90	90	3.0
100	162	162	115	115	3.0
150	218	218	169	169	3.0
200	273	273	220	220	3.0
250	328	330	274	274	3.0
300	378	-	325	-	3.0
350	438	-	368	-	3.0
400	490	-	420	-	3.0
450	540	-	470	-	3.0
500	595	-	520	-	3.0
600	695	-	620	-	3.0

Toughgask reusable gaskets can be used in nearly all applications to seal metallic flange joints. They are far superior and cost effective compared with other designs such as envelope gaskets as they are reusable many times. Their design is extremely robust and they are very easy to install.

The Toughgask gasket offers superior performance than a standard virgin PTFE gasket as its stainless steel core prevents cold flow of the PTFE which can lead to joint failure.



Flange sprayguards are used to protect personnel from uncontrolled spray out from a failing flange joint. They should always be considered when installing any piping system carrying toxic or corrosive chemicals. By controlling the leak and protecting personnel and surrounding plant equipment from chemical contact considerable cost savings can be made. They help to minimise accidents on plant preventing costly plant down time, unplanned absenteeism, HSE investigations etc.

The CRP Flange Spray Guards Roll has been designed to be very cost effective, manufactured from hardwearing polypropylene they have very good chemical resistance, are UV resistant and can be reused.

Very easy to install, they are supplied as a roll, the correct length is cut from the roll and then wrapped around the flange joint, they are secured with a stainless steel self tapping screw.

If a spray out were to occur the spray is safely deflected diminishing the force of the spray.

The spray out is deflected not contained so the guard is never pressurised.

Three widths of Spray Guard will cover most piping installations

The Spray Guards are suitable for use on piping ranging from -40°C to +110°C.

Available by the metre, CRP Spray Guard is available in 5 roll widths, 50mm, 70mm, 100mm, 140mm and 180 mm to cover flange joint sizes from 15mm up to 600mm nominal bore. Typically only 2 or 3 widths can cover most installations on site.

The table below shows the correct width required for typical flange joints and the cut length of sprayguard required for each flange nominal bore.



Nominal Bore mm	Length Required PN 10 PN 16		Width of roll required for each type of mating flange connection to be shielded		
	mm	mm	Fixed / Fixed	Fixed / Rotating	Rotating / Rotating
15	360	360	50	70	70
20	390	390	50	70	100
25	420	420	50	70	100
40	530	530	50	70	100
50	580	580	50	70	100
80	690	690	50	70	100
100	750	750	70	100	100
150	960	960	70	100	140
200	1130	1130	100	100	140
250	1300	1330	100	140	140
300	1460	1510	100	140	140
350	1650	1700	100	140	180
400	1840	1880	140	140	180
450	1990	2070	140	180	180
500	2170	2310	140	180	N/A
600	2510	2700	140	180	N/A



Flange Safety Spray Shields provide protection to personnel and plant equipment in the surrounding area if a flange joint should start to leak. CRP would strongly recommend that they should be installed as part of any flanged piping system conveying hot, corrosive or toxic chemicals. Our flange guards can be used on all our piping systems up to 200°C and are easy to install with 2 tie cords. Our standard design has PTFE coated extra strong 3 ply glass fibre fabric with a clear FEP window to allow easy inspection of the joint. CRP's PTFE lined products are mainly used to convey very corrosive products. Safety regulations stipulate that consideration must be made for reducing the effects of leaks to the environment and personnel. CRP safety shields are a recommended addition to any piping system and would be looked on favourably by the regulating authorities.

- Recommend by Insurance companies.
- Helps to contain leaks until the pipe line can be isolated.
- Reduces risk of operator and plant damage.
- Clear window allows easy inspection of flange joint.
- Heavy duty 3-ply PTFE coated glass fibre construction.
- FEP and PTFE glass fibre construction for use at temperatures up to 200° C.
- One size covers all joint thicknesses from fixed / fixed flanges to rotating / rotating
- Manufactured from UV and weather resistant materials for long life.
- Available to suit both DIN and ASME150 flange sizes.
- Available from stock at CRP up to size DN150
- Please contact CRP for a quotation for spray guards.

We also supply matching bellows spray guards, which not only protect against spray out from failing flange joints but also covers the whole PTFE bellows.



Static Dissipating Lined Piping & Spikie Earthing Washers

CRP can supply lined pipe and fittings with static dissipating PTFE / PFA liners, commonly referred to as having 'Antistatic' properties. By combining the PTFE or PFA fluoropolymers with a small amount of carbon filler the liners are able to conduct any build up of static from the bore of the pipe to the steelwork.

There are many ways that electrostatic charge can be generated and accumulate. Static electricity develops when two different materials are brought together and then separated, one of the materials acquires electrons from the other material and becomes positively charged.

In pipe lines carrying low conductivity fluids, the fluid can lose some of its electrons and these can accumulate or 'charge' the pipework. This process is known as flow electrification, the charge build up increases as flow velocity and pipe nominal bore increase.

CRPs standard virgin fluoropolymers have excellent insulating properties, so in certain situations electrical charge can accumulate on the liner surface through flow electrification. CRPs static dissipating liners allow any build up of charge to safely dissipate through the liner to the steel pipe. For the electrical charge to dissipate to earth the steel pipe must be sufficiently earthed, typically using earth bonding clamps, spikie washers, star washers on bolts, earthing studs or lugs etc. CRP are able to supply the pipe spool with earth studs/lugs or Spikie® earthing washers already welded or fitted in position.



The fillers used to provide the electrical continuity do not impair in any way the mechanical and chemical resistance of the liners. They exhibit the same performance as virgin liners, the conducting agent used within the liners are stable and are not subjected to chemical attack and will not leach into the process fluids.

All of our lined pipe and fittings range can be supplied with static dissipating liner.

Spikies

To aid with earth bonding of the steel pipe CRP has specially developed our own Spikie™ washer which is a very cost effective alternative to earth bonding straps.

Spikies™ are simply slipped into place between the loose flange and stub end on a pipe spool or fitting, and the joint made using star washers and studs as on a fixed flange joint. Once in place the centring lugs ensure that the raised points on the Spikies® are positioned to bite into the front of the flange face and the back of the stub end, thus providing earth continuity from rotating flange to fitting / spool. Star washers on at least one connecting bolt must be used in conjunction with the Spikie to allow continuity across the joint.

Development

The extensive design, development and testing programme for Spikies® has ensured that the optimum spring steel substrate and nickel corrosion protection coating materials have been used, along with a design that makes Spikies® a truly durable fit and forget solution to process plant pipework earth continuity issues.

Nb. CRP recommends the replacement of Spikies™ whenever a joint is split.

Cost and Reliability

The Spikie provides a robust and cost effective solution to achieving earth continuity between the pipe body and a rotating flange. It can be supplied factory fitted or can easily be retro-fitted in the field.



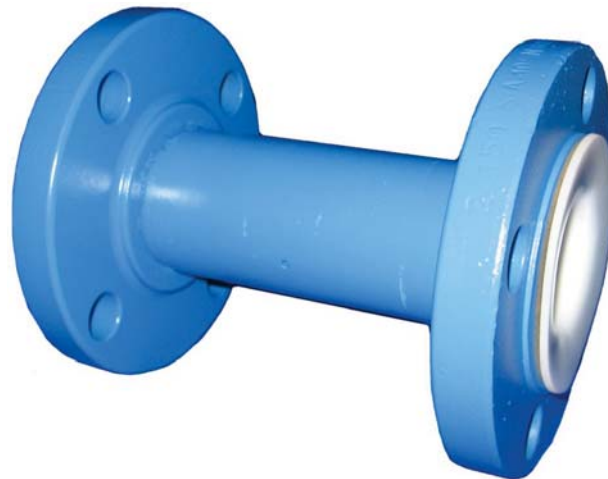

Bromine along with other members of the halogen family is highly reactive, over time this can lead over time to molecules permeating through fluoropolymer linings used to carry this highly corrosive chemical. Working closely with a global agricultural chemical manufacturer CRP has developed a special lined piping range utilising super-weight paste extruded PTFE liners and PFA moulded fittings.

PFA is well known for its excellent permeation resistance properties often double that of PTFE and a natural choice for Bromine applications. Life spans of piping are extended by supplying extra heavy wall PTFE liners up to 50% thicker than our standard heavy wall liners

Super Weight Piping Specification

- PFA lined fittings – Heavy wall typically 5mm or more thick.
- PTFE paste extruded liners. Offer superior permeation resistance than isostatically formed liners.
- ¼” vent bosses supplied at each end of pipe spools, fitted with PTFE vent plugs, help minimise local corrosion.
- All usual CRP quality, testing & inspection standards adhered to.

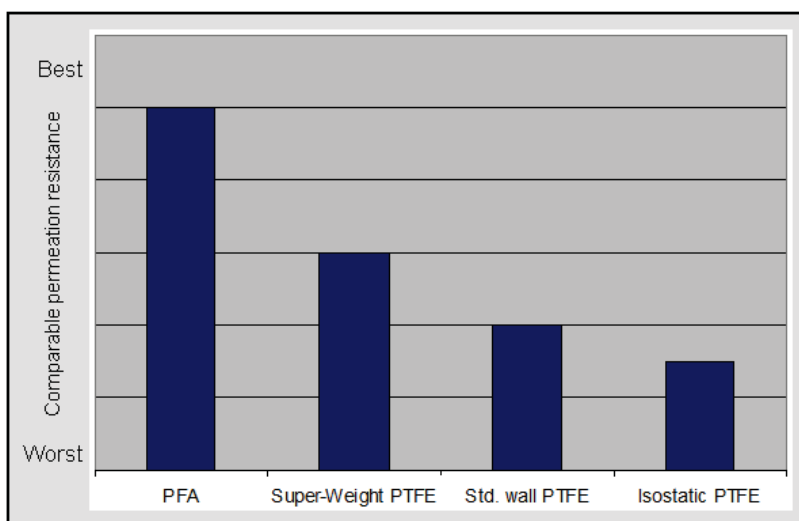

Typical permeation failure of isostatically formed liner

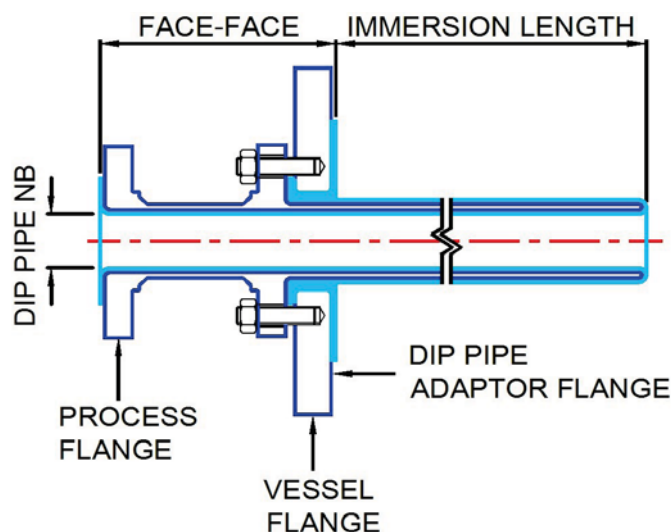

CRP dip pipes have a wide array of uses. Typically they are used to charge a reactor below the liquid level, to extract samples from the reactor as part of one of our sampling systems, or to drain liquid from a vessel without the need of side or bottom outlet.

CRP dip pipes are manufactured from a carbon steel fabricated construction with a continuously lined paste extruded PTFE liner. One piece of PTFE liner lines and protects both the inner and outer diameters of the dip pipe. Our advanced manufacturing techniques enable us to produce dip pipes without any pinched or welded ends eliminating a potential weak point completely.

Having all wetted parts in PTFE gives excellent corrosion resistance. Dip pipes can be supplied straight or curved to angle liquor to the side of the reactor etc.

Powerful agitator blades can create a lot of stress on components installed in a reactor vessel. Before we supply any dip pipes we thoroughly check that the mechanical strength of the dip pipe will be sound against the specific process conditions. This is extremely important to save on very costly breakages.

Nominal Bore	Face to Face	Maximum Immersion	PTFE liner Thickness	Vessel flange range	Minimum id of vessel flange
DN	mm	mm	mm	DN	mm
25	150	2850	2.5	40 - 600	45
40	150	2850	2.8	50 - 600	60
50	150	2850	3.0	80 - 600	73
80	150	2850	3.0	100 - 600	101
100	150	2650	4.5	150 - 600	130



Entry Pipes / Nozzle liners

Where there is little need for mechanical strength offered by CRPs lined steel dip pipes, CRPs Entry pipes can be an ideal low cost solution to introduce liquor into a storage vessel etc.. They are manufactured from paste extruded PTFE flared one end to raised face dimensions to connect between suitable mating flanges.

They can be supplied in any length up to 6000mm long and generally available in sizes from DN 20 to DN 150. Entry pipes are often used to protect the bores of glass lined vessels from mechanical damage, being a sacrificial sleeve.